

B337

Long-Term Care Low Profile Bed

User Manual



DEALERS: *This manual MUST be given to the user of the bed.*

USER: *Before using this bed, read this manual and save for future reference.*

Table of Contents

1.0	GENERAL INFORMATION	2
1.1	STANDARD SYMBOLS AND WARNING LABELS.....	2
1.2	INTENDED USE.....	3
1.3	SAFETY PRECAUTIONS.....	3
2.0	TECHNICAL SPECIFICATION	6
3.0	EQUIPMENT ASSEMBLY	7
3.1	UNPACKING THE BED.....	7
3.2	ASSEMBLING THE BED.....	8
4.0	EQUIPMENT OPERATION	13
4.1	POSITIONING THE BED.....	13
4.2	EXTEND THE LENGTH OF THE BED FROM 80" TO 84" OR 88".....	14
4.3	EXTEND THE WIDTH OF THE BED FROM 35" TO 39" OR 42".....	14
4.4	ADJUSTING THE EXTENDED HEEL LIFT.....	15
4.5	USING THE CONTROLLER.....	16
4.6	USING THE STAFF CONTROL.....	17
4.7	RESETTING THE BED.....	17
4.8	OPERATING THE BED RAILS.....	18
5.0	TROUBLESHOOTING GUIDE	19
6.0	LIMITED WARRANTY	20
	APPENDIX – SERVICE RECORD	21

1.0 GENERAL INFORMATION

1.1 Standard Symbols and Warning Labels

Warnings

Signal words with symbols are used in this manual to highlight hazards or unsafe practices which could result in personal injury or property damage. See the information below for definitions of the signal words and symbols.



DANGER

Danger indicates an imminently hazardous situation which, if not avoided, will result in death or serious injury.



WARNING

Warning indicates a potentially hazardous situation which, if not avoided, could result in death or serious injury.



CAUTION

Caution indicates a potentially hazardous situation which, if not avoided, may result in property damage or minor injury or both.



IMPORTANT

Indicates a hazardous situation that could result in damage to equipment or property if it is not avoided.



Gives useful tips, recommendations and information for ease of use.

1.2 Intended Use

The Costcare Long-Term Care Low Profile Beds are intended for use in within an institutional healthcare environment, i.e. nursing homes, rehabilitation care, assisted living.

The bed is NOT a transport device. The wheels on the bed are for positioning the bed only. These shall be locked at all times when carrying a patient.

The beds are intended for users who fully understood the content of this manual and is not intended for use by children.

1.3 Safety Precautions

1.3.1 Assembling the Bed



WARNING

DO NOT overtighten the mounting hardware as this will damage the mounting brackets.

DO NOT modify this equipment without authorization of the manufacturer. Doing so will void the warranty.

DO NOT use accessories that are not designed or approved for use with the bed.

1.3.2 Operating the Bed



WARNING

DO NOT operate your bed until it is fully assembled and checked.

DO NOT exceed maximum weight limitations of the bed.

ALWAYS make sure the power cable is clear of any moving parts of the bed before switching on the power.

ALWAYS keep hands and fingers away from moving parts to avoid injury.

ONLY use appropriate mattresses and ALWAYS adjust the mattress retainer system accordingly to ensure the mattress is fixed in place.

The mattress platform shall be kept in a flat position if the patient's condition could lead to patient entrapment.

ALWAYS keep the bed at the lowest position when the patient is unattended.

1.3.3 Performing Maintenance



WARNING

ONLY qualified personnel should carry out the bed maintenance.

DO NOT attempt to open the pre-sealed actuator or obtain local service, for it will VOID the warranty and might result in damage. Consult your dealer or manufacturer for further information.

Inspect the casters every six months to check for tightness and wear.

Regular maintenance of bed and accessories is necessary to ensure proper operation. DO NOT overtighten mounting hardware. This will damage mounting brackets.

1.3.4 Electrical and Earthing



WARNING

EARTHING

DO NOT, under any circumstances, cut or remove the earthing prong from any plug. Some devices are equipped with three-prong (earthing) plugs for protection against possible shock hazards. Where a two-prong wall receptacle is encountered, it is the personal responsibility and obligation of the customer to contact a qualified electrician and have the two-prong receptacle replaced with a properly earthed three-prong wall receptacle in accordance with the regional and national regulations. If you must use an extension cable, use ONLY a three-wire extension cable having the same or higher electrical rating as the device being connected.

DO NOT use if the power cable is cut, frayed or loosely connected to the device. Power supply cable may be damaged by inappropriate handling, e.g. by kinking, shearing or other mechanical damages. The POWER SUPPLY CABLE is only replaceable by SERVICE PERSONNEL.

1.3.5 Disposal



WARNING

This product has been supplied from an environmentally aware manufacturer.

Where backup battery is used, DO NOT dispose of batteries in normal household waste. They MUST be taken to a proper disposal site. Contact your local waste management company for information.

This product may contain substances that could be harmful to the environment if disposed of in places (landfills) that are not appropriate according to legislation.

Please be environmentally responsible and recycle this product through your recycling facility at its end of life.

1.3.6 Radio Frequency Interference



WARNING

Most electronic equipment is influenced by Radio Frequency Interference (RFI). CAUTION should be exercised with regard to the use of portable communication equipment in the area around such equipment. If RFI causes erratic behavior, switch the power OFF IMMEDIATELY. DO NOT turn the Power Switch ON while transmission is in progress.

2.0 TECHNICAL SPECIFICATION

B337		
OPERATING RANGE	Bed Height	7" – 30"
	Back Rest Angle	0° - 65°
	Knee Break Angle	0° - 35°
	Additional Manual Leg Lift	Yes, various positions
	Trendelenburg / Reverse Trendelenburg	± 12°
WEIGHT LIMIT	Safe Working Load (SWL)	600 lbs
	Max. Patient Weight	550 lbs
WEIGHTS & DIMENSIONS	Sleeping Surface Dimension Width x Length	35"-39"-42" x 80"-84"-88"
	Caster Size	3"
	Weight IN Carton	290 lbs
	Weight OUT of Carton	251 lbs
ELECTRICS	Power Supply (V/PH/Hz)	100-240V/1ph/50-60Hz
	Power Consumption (Max)	288 W
	Number of Motors	4
	Protection Class	IPX4
	Insulation Class	II Type B
	Duty Cycle	Interruption 10%, Max. 2 min./18min.
Battery backup	Yes, optional	
ENVIRONMENT	Operating Temperature	40°F - 105°F (5°C - 40°C)
	Storage Temperature	15°F – 120°F (-10°C - 50°C)
	Operation & Storage Humidity	20% - 80%
	Operation & Storage Atmospheric Pressure	700 - 1060 hPa
	Operation & Storage Altitude	≤ 3000 m
	Noise Level	< 50 db(a)

3.0 EQUIPMENT ASSEMBLY

3.1 Unpacking the Bed



WARNING

To avoid injury, DO NOT attempt to remove the bed from the carton without assistance.

- I. Unpack the components from the shipping cartons.
- II. Upon unpacking your bed, the package should contain all of the following components.
- III. Examine exterior of the bed components for nicks, dents, scratches or damages.

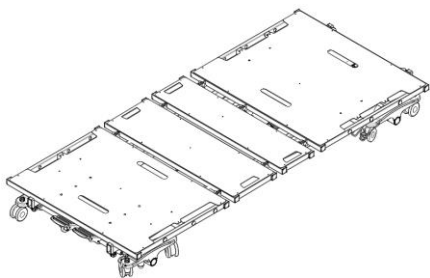

Bed Assembly x 1

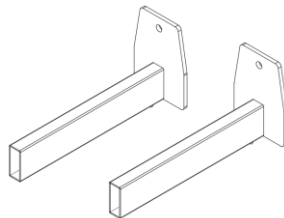

Headboard Frame x 2

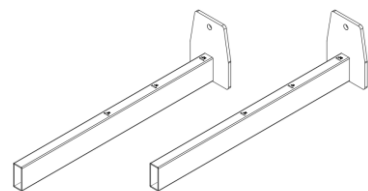

Footboard Frame x 2

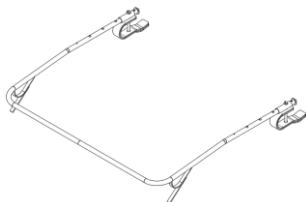

Wall Bumper Bar x 1

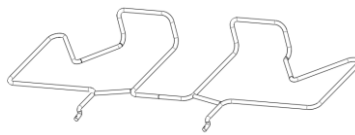

Bed-end Mattress
Retainer x 1

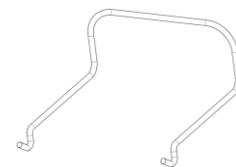

Mattress Retainer x 4



IMPORTANT

Store the repackaged bed in a dry area. Do not place other objects on top of the repackaged bed.



Unless the bed is to be used immediately, retain boxes, containers, and packing materials for use in storing until use of bed is required.

3.2 Assembling the Bed

3.2.1 Assembling the head/foot board brackets to the bed

1. With the bed raised to its highest position, step on the locking levers to lock the casters on at the foot end of the bed.
2. Turn and loosen the two black turn knobs on the underside of the bed assembly insertion slots on the head side of the bed.
3. Slide the headboard brackets into the slots (the headboard brackets are shorter than the footboard brackets). Tighten the black knob to secure the brackets in place.
4. Repeat the same procedure for the footboard bracket installation.

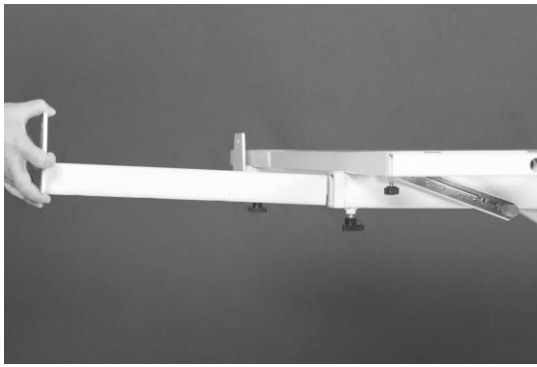

3.2.2 Assembling the headboard

1. With the mounting plates on the headboard facing the bed, slide the mounting plate groove onto the headboard mounting bracket's vertical support.
2. Insert the lock pin through the mounting plate into the headboard to secure the headboard in place. Repeat on the other mounting plate.
3. Repeat the same procedure for footboard installation.



3.2.3 Assembling the footboard with staff control

1. Ensure the power is turned off before installing the footboard with staff control.
2. Following the headboard installation procedure for foot board installation.
3. An extension port is provided on the side of the bed frame. Hinge open the cap on the extension port.



4. Connect the footboard cord to the extension port, hinge close the cap to secure the connection.
5. Switch the power supply back on.

3.2.4 Installing the mattress retaining system

1. Locate the mounting holes for the mattress retainers in the bed deck. Align and insert the mattress retaining wires through the pre-cast holes.
2. Repeat the procedure for all four side mattress retainers.

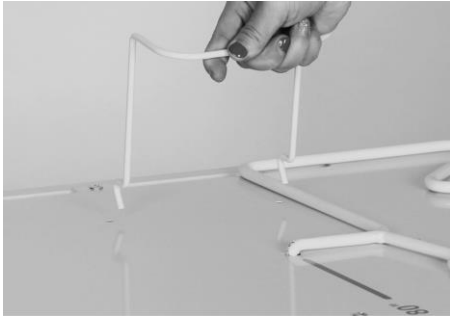

3. Insert the bed end mattress retainer in the foot side of the bed deck through the precast holes.
4. Ensure the all mattress retainers are flat against the bed deck.

Certain bed models have multiple sets of holes for various bed widths and lengths. Adjust the mounting position accordingly for different sized mattresses. The mounting holes are labeled with the corresponding size. Ensure the mattress fits snugly within the mattress retainers.

3.2.5 Installing the wall bumper bar

1. Clip the wall bumper bar assembly on to the caster support shaft at the head end of the bed. Ensure the bumper bar foot stand is facing the floor.
2. Slide the bar to adjust the length. Insert the pin through the bar through the holes on the bar to fix the length and lock the assembly in place.



3.2.6 Installing the rails or assist bars

1. Before installing the rails or bars, the bed should be in a flat position.
2. Unclip the metal snap ring and remove the metal pins from the mounting brackets.

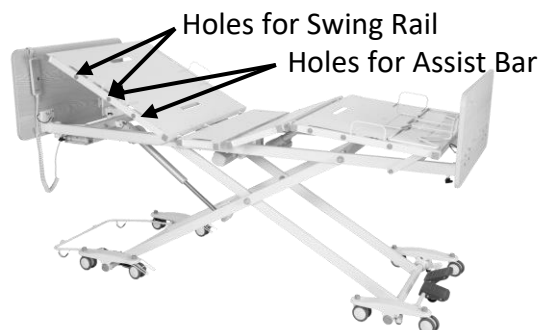
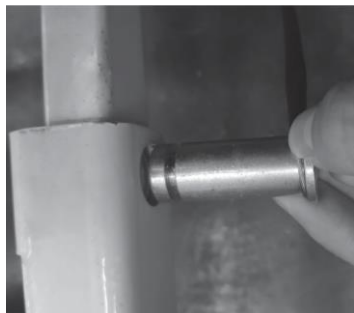

3. Remove cover for the appropriate holes.
4. Slide the U-shaped insert into the assist bar bracket. Place the rail bracket onto the edge of the bed decking. Align the rail bracket mounting holes with the bed deck mounting holes.

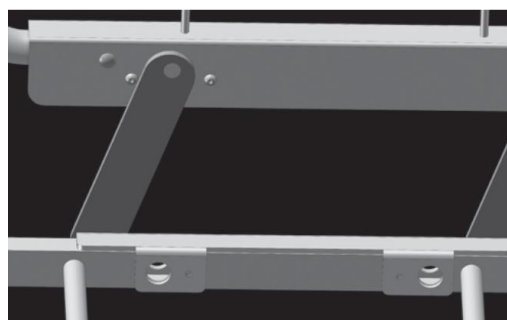

5. Re-insert the metal pins from the outside edge of the bed through the mounting holes and secure with snap rings on the inside edge of the bed. Make sure the snap rings are positioned in the groove of the metal pins.

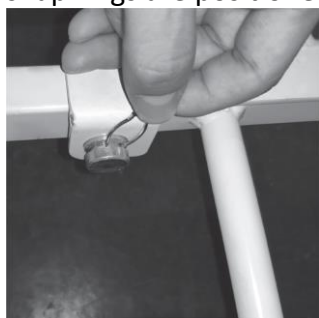

6. If the bed rail or bar has additional Allen screws, tighten the Allen screws next to the metal pins.
7. Repeat the same procedure to install the other rail.

3.2.7 Control box connections

Upon opening the control box, each motor connection port is color coded for ease of identification.



DC 1 2 3 4 5 6 7 8

- DC. Battery Backup Port
- 1. Backrest Motor
- 2. Knee-break Motor
- 3. Hi-Lo Motor (Front)
- 4. Hi-Lo Motor (Rear)
- 5. Underbed Lighting
- 6. Spare
- 7. Staff Control
- 8. Hand Pendant

3.2.8 Installing battery backup

1. Switch the power supply off when installing the backup battery.
2. Affix the backup battery with nuts and bolts to the side of the control box, on the same holding plate.

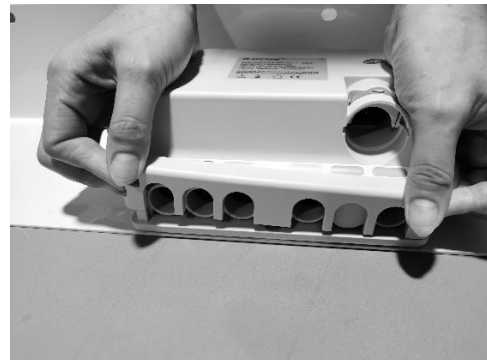
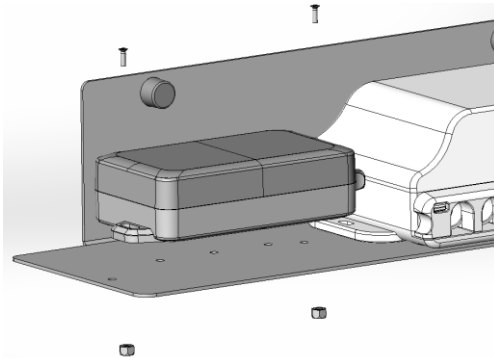

3. Open the control box locking lid by pressing in the sides and lift it up, to expose the connection ports.
4. Connect the backup battery cord to the control box. The connection port is indicated with a battery symbol above.
5. Close the locking lid, there should be an audible click, switch the power supply back on.

4.0 EQUIPMENT OPERATION

4.1 Positioning the Bed

1. To lock the bed, step on the red lever at the rear of the bed.



2. The caster guides on both sides of the head end casters should be lowered to prevent sideway movements. The fork opening of the caster guide should sit on top of the caster locking tab, limiting any swivel action.



3. To unlock the casters, step on the green lever at the rear of the bed. Lift up the caster guides on the head end casters to allow free moment.

NOTE: Head end caster must be unlocked when raising and lowering the bed. Head end caster guide should be lowered onto the caster when bed is in use.

4.2 Extend the Length of the Bed from 80" to 84" or 88"

1. Loosen the two black knobs located on the underside of the bed frame securing the footboard frame. (Refer to Section 3)
2. Pull the footboard frame away from the bed squarely with both hands to the required length. The distances are marked on the footboard frame, 80", 84" and 88". Tighten the securing knobs once desired length is set.
3. Adjust the bed end mattress retention frame to the required position. The extension Length are marked on the bed platform.



4.3 Extend the Width of the Bed from 35" to 39" or 42"

1. Under each bed platform there is a turn knob and a sprung plunger. Loosen the turn knob.
2. Pulled down the sprung plunger and at the same time slide out the extension piece to the required length. There should be an audible click indicating that the extension piece is locked in place.



3. Repeat the same procedure on all bed sections and on both sides of the bed.
4. Adjust the mattress retainers accordingly.

5. To extend the headboard, lift up and flip the extension piece on the back of headboard. Reinsert the steel plates into the mounting brackets on the main headboard.



4.4 Adjusting the Extended Heel Lift

1. Grip the end section of the bed platform. Lift up slowly to the preferred height. Ensure there is an audible click indicating that the deck is locked in place within the Ratcheting Bracket.
2. To lower the end deck to its original position, lift it up to the highest position and slowly lay the bed section back down.



4.5 Using the Controller

The UP arrow (▲) indicates raising the corresponding parts of the bed.

The DOWN arrow (▼) indicates lowering the corresponding parts of the bed.

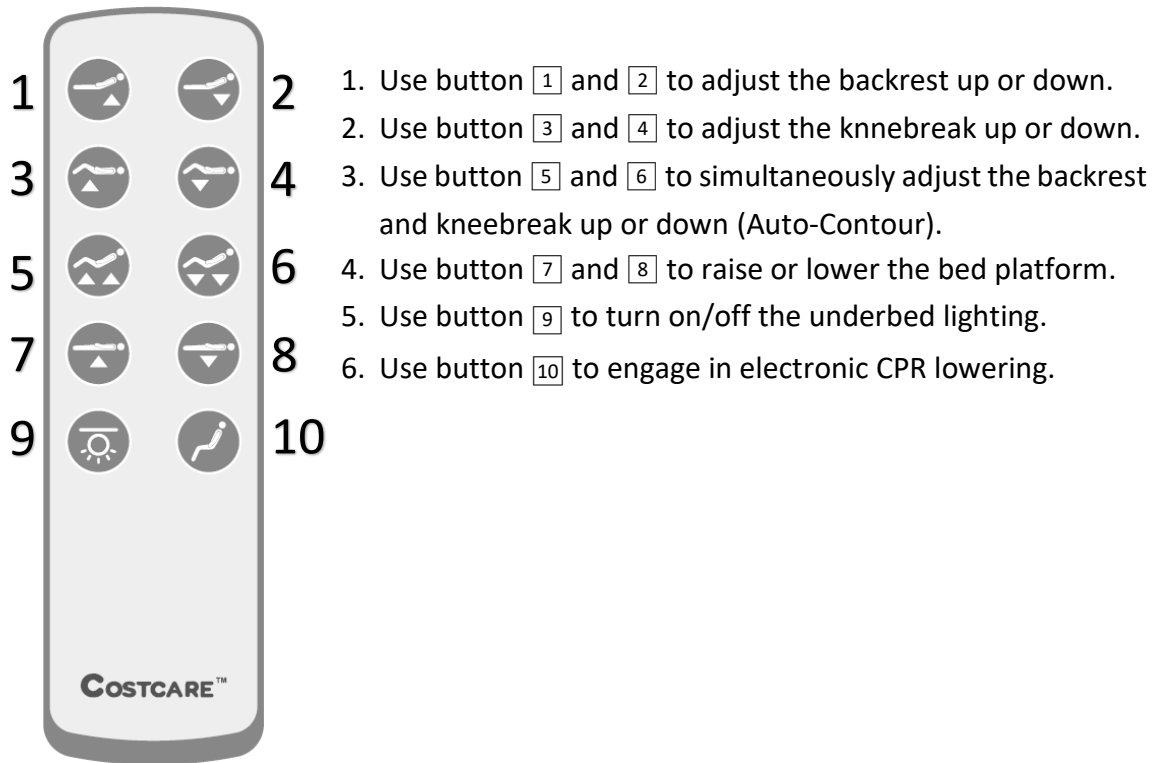

4.6 Using the Staff Control

The UP arrow (▲) indicates raising the corresponding parts of the bed.

The DOWN arrow (▼) indicates lowering the corresponding parts of the bed.

The staff control can lockout functions on the hand pendant. To engage the lockout, hold down the “Lock” button and press the UP arrow for the specific function. The light indicator for the function will switch on.

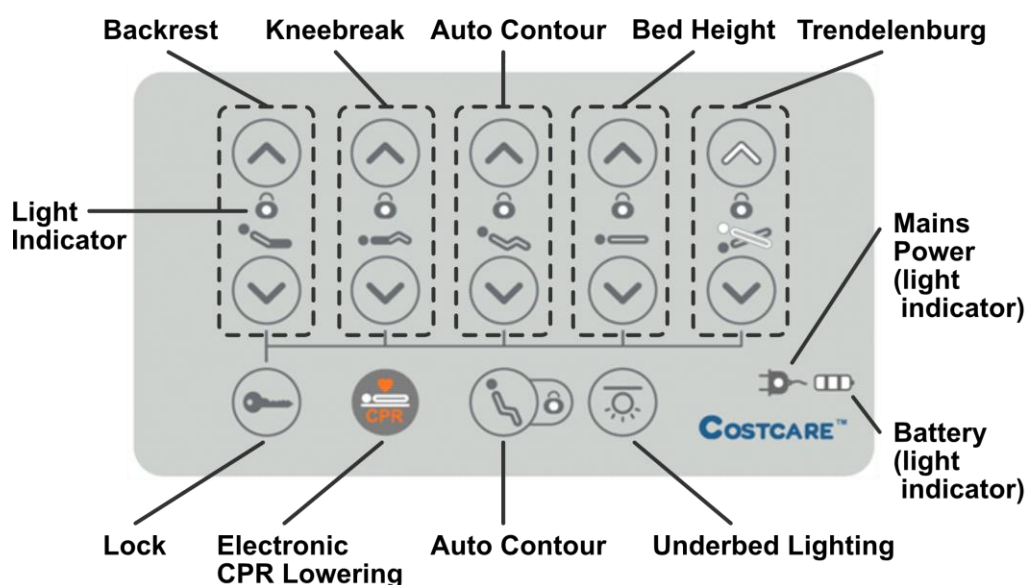

4.7 Resetting the Bed

Where a connection fault is identified and rectified, the control system will require a reset in order to operate again.

1. Pressed and hold the control button for lowering the backrest and kneebreak. Continue to hold down the button for 10 seconds after the mattress platform is completely flat.



2. Pressed and hold the control button for raising the mattress platform. Continue to hold down the button for 10 seconds after the mattress platform reaches the highest position.



4.8 Operating the bed rails

Metal Swing Rail

Raise Bed Rail: Pull the bed rail upwards until the rail is securely locked in place.

Lower Bed Rail: Squeeze the release lever at the bottom corner of the bed rail and slowly lower the bed rail to its lowest position.



Composite Swing Rail

Raise Bed Rail: Pull the bed rail upwards until the rail is securely locked in place.

Lower Bed Rail: Press the release button, slowly lower the rail to its lowest position.



Q-Bar

**Parallel/
Perpendicular
Alignment:** Lift up and rotate the bar until it is parallel or perpendicular to the bed edge. Lower the bar and ensure it is securely locked in place.

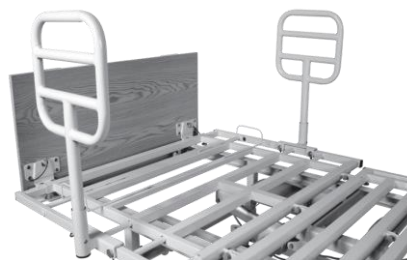

Pivot Assist Bar

Raise Assist Bar: Pull the bar upwards until it is securely locked in place. Ensure the release button is engaged

Lower Assist Bar: Pull the release knob and slowly lower the bar to its lowest position.



5.0 TROUBLESHOOTING GUIDE

SYMPTOMS	POSSIBLE FAULTS	POSSIBLE SOLUTIONS
Bed idle when hand pendant buttons are pressed.	Adjustment may be at the maximum or minimum position	Check if other buttons are working.
	Power cord not connected or damaged	Ensure the power cord is properly connected to the electrical socket and the bed.
	Hand pendant or actuator connectors are loose	Ensure tight connection of all connectors to control box.
	Load is too heavy	Ensure the load weight is within the designated capacity. Reduce the load.
	Control system requiring a reset	Reset the electronic system using the hand pendant.
Casters/Brakes noisy or stiff.	Debris or fluff in bearings	Replace casters.
Noisy or dry sound from pivots.	Needs lubrication.	Lubricate your bed.
Unusual noise from actuator.	Actuator is worn or damaged or spindle is bent.	Replace the actuator. Contact your supplier.
Head/footboard unstable.	Head/footboard frame not tightly secured.	Refer to Equipment Assembly



If problems persist following the above remedial procedures, please contact your dealer or the manufacturer.

6.0 LIMITED WARRANTY

This Costcare product is warranted to be free of defects in material and workmanship for one year of the original purchaser.

This device was built to exact standards and carefully inspected prior to shipment. This Limited One Year Warranty from the date of original purchase is an expression of our confidence in the material and workmanship of our products and our assurance to our customers for years of dependable services.

In the event of a defect covered by this warranty, Costcare will, at Costcare's option, repair or replace the device. The warranty provides only for replacement of defective parts and does not cover shipping and labor charges. Costcare's sole obligation and your exclusive remedy under this warranty are limited to such repair and/or replacement.

This warranty does not cover device failure due to the user misuse, abuse, negligence, or normal wear and tear. This warranty does not extend to non-durable components, such as rubber accessories, casters and grips, which are subject to normal wear and require periodic replacement.

This warranty shall not apply to serial numbered devices if the serial number has been removed, or altered, or defaced, or to defect or damages caused by unauthorized parts, attachments or repairs, negligence, operated by incorrect voltages, accident and circumstance beyond Costcare's control, or improper operation, maintenance or storage.

If you have a question regarding your Costcare device or this warranty, please contact an authorized Costcare Dealer.



www.costcaremed.com

1-714-485-2206



www.costcaremed.com
1-714-485-2206

Date of Issue: 02/01/2021